

■仕様

①	ブラケット	SUS430 #180仕上	t 3.0mm
②	平棚	SUS430 No. 4 仕上	t 0.8mm

●取付穴の詳細

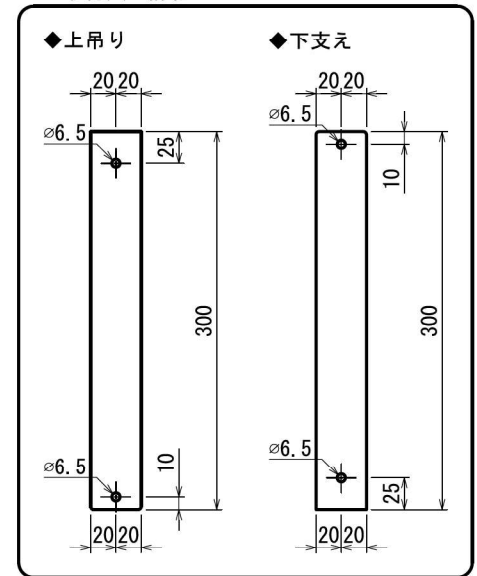

◆上吊り

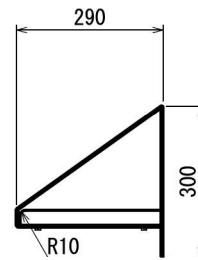
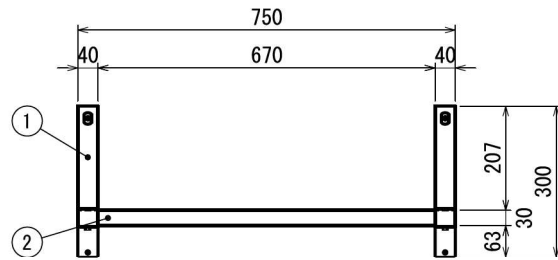
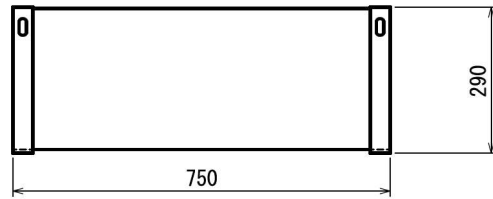

◆下支え

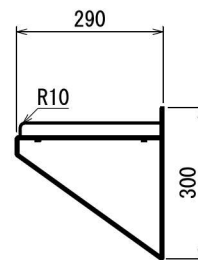
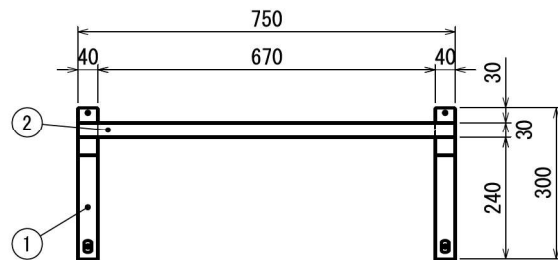
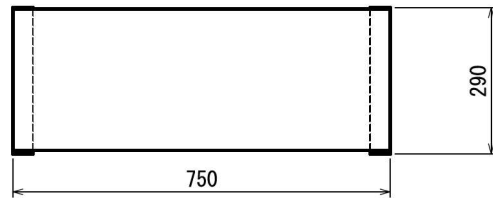

ニッサンハロー (株)

現場名	品名		
日付	製図	御承認	平棚

型式	N F- 7530
寸法	750 × 290 × 300

台数	
図番	縮尺 1/15